

1. Making egg heads - Decorate the eggs with face and hair.

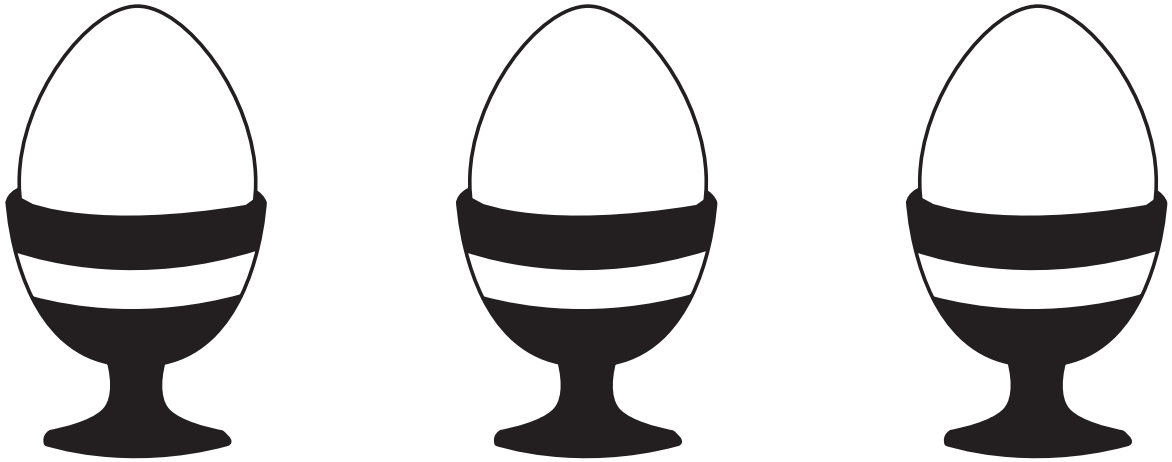

2. Look at the picture of the egg hunt and count how many eggs are hiding.
You can also colour the picture in.

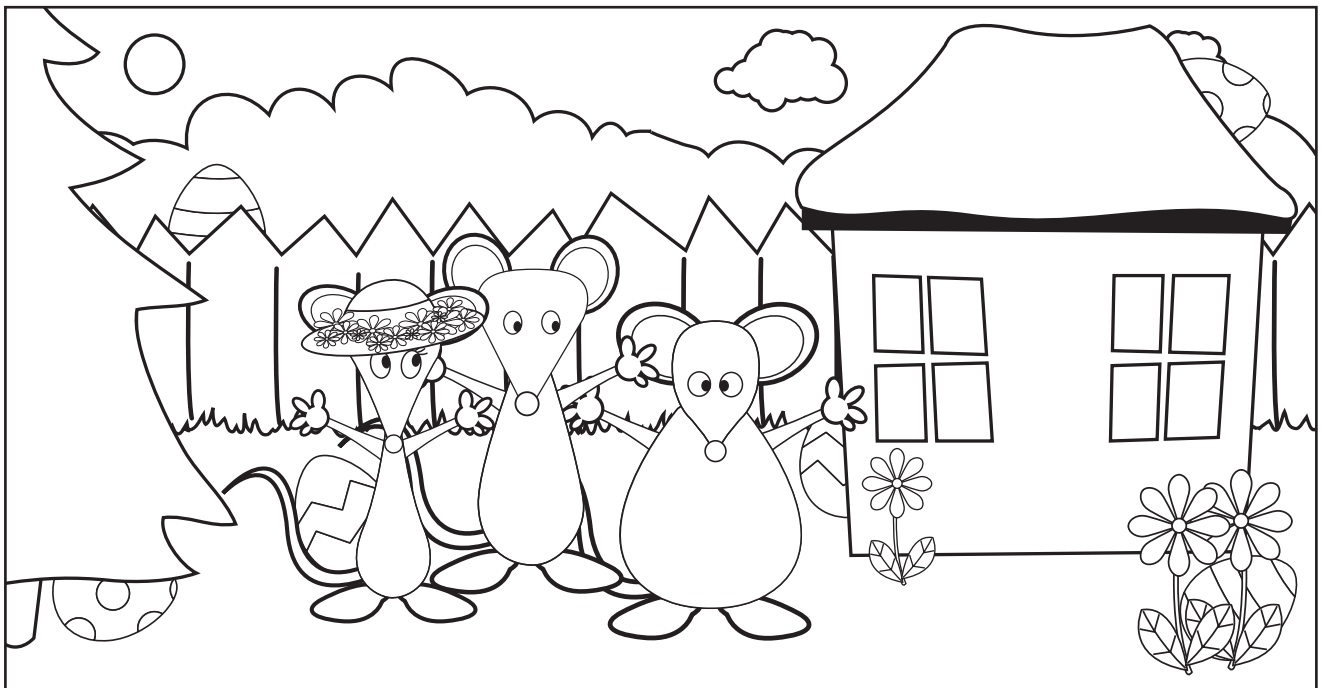

3. Letter puzzle - Each Easter bonnet has a word on top, but it is jumbled up. Can you write the correct word underneath?

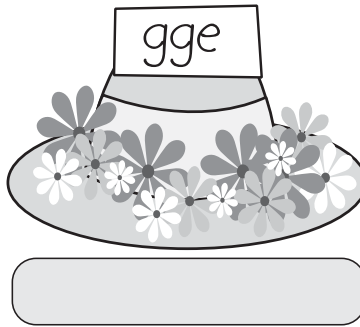
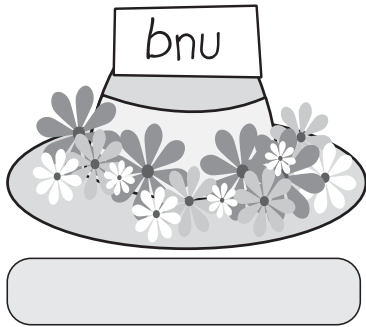

4. Colour the egg by finding the right numbers.

Find the answers to these sums to match the colours.

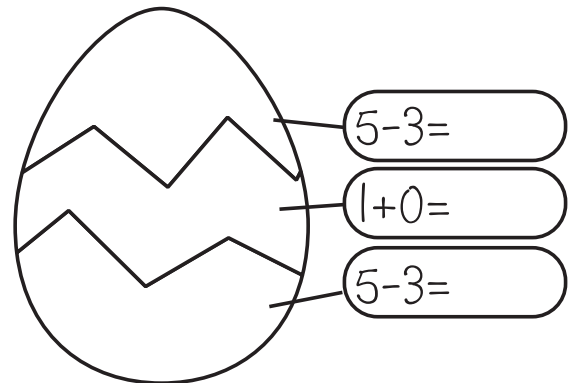
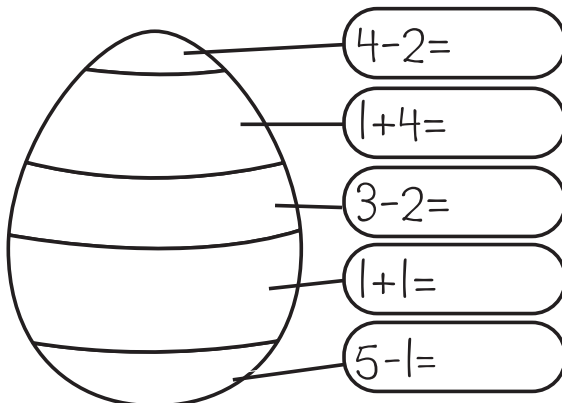
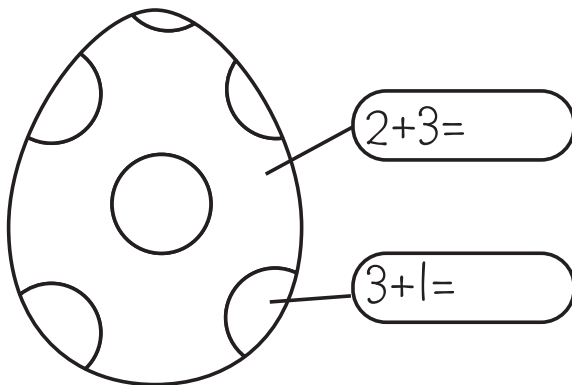

1 = red, 2 = yellow, 3 = green,
4 = blue, 5 = orange

5. Spring Wordsearch - Find and circle the words in the wordsearch opposite.

| | | | | | | | |
|---|---|---|---|---|---|---|---|
| b | a | s | k | e | t | g | t |
| o | f | l | o | w | e | r | s |
| n | b | q | s | m | a | b | p |
| n | o | i | k | u | s | u | r |
| e | p | n | r | j | n | n | i |
| t | r | v | d | d | y | n | n |
| c | h | i | c | k | s | y | g |
| e | a | s | t | e | r | x | r |

basket

easter

birds

flowers

bonnet

spring

bunny

sun

chicks